

LIGHT+

THE SOLUTIONS OF LED



LED Lighting Professional
& Advertising LED Catalogue



PERUSAHAAN

PT. SURYA CITRA TEKNIK CEMERLANG adalah Perusahaan Swasta Indonesia (PMDN) yang didirikan pada tahun 2009 dengan bisnis utamanya adalah manufaktur peralatan listrik yaitu Lampu LED, Solar Panel, Power Supply, Running Text dan LED Videotron yang disiapkan untuk pasar nasional dan internasional.

Dikenal dengan Merk **LIGHT+** kami sangat mengedepankan kualitas, kehandalan dan ketahanan dengan melalui metode uji yang telah memenuhi standar.



VISI :

“ MELANGKAH PASTI DAN USAHA TIADA HENTI “

MISI :

Menjadi salah satu perusahaan penghasil komponen listrik terkemuka di Indonesia yang mengutamakan kepuasan pelanggan dengan menjaga mutu & kualitas pekerjaan, keselamatan & kesehatan kerja serta lingkungan.

SERTIFIKASI ISO



LED BULBS SERIES



LED Bulbs 5W

Tegangan : 70 ~ 285 VAC
 Daya : 5W
 Model : LPB05
 LPBD05 (Dimmable)
 Frekuensi : 50 ~ 60 Hz
 Power Factor : ≥ 0.70
 Power Efisiensi : $\geq 90\%$
 LED Efisiensi : $\geq 110 \text{ lm/Watt}$
 LED Lifetime : 50.000 jam
 CCT : 2700 ~ 3000K



LED Bulbs 10W

Tegangan : 70 ~ 285 VAC
 Daya : 10W
 Model : LPB10
 LPBD10 (Dimmable)
 Frekuensi : 50 ~ 60 Hz
 Power Factor : ≥ 0.70
 Power Efisiensi : $\geq 90\%$
 LED Efisiensi : $\geq 110 \text{ lm/Watt}$
 LED Lifetime : 50.000 jam
 CCT : 2700 ~ 3000K



LED Bulbs 15W

Tegangan : 70 ~ 285 VAC
 Daya : 15W
 Model : LPB15
 LPBD15 (Dimmable)
 Frekuensi : 50 ~ 60 Hz
 Power Factor : ≥ 0.70
 Power Efisiensi : $\geq 90\%$
 LED Efisiensi : $\geq 110 \text{ lm/Watt}$
 LED Lifetime : 50.000 jam
 CCT : 2700 ~ 3000K



Dimensi

Model	Lebar	Tinggi
LPB05	550mm	115mm
LPB10	550mm	118 mm
LPB15	670mm	135 mm

LED BULBS EMERGENCY SERIES



LED Bulbs Combo 12W

Tegangan : 70 ~ 285 VAC
 Daya : 12W
 Model : CMB12
 CCT : 2700 ~ 3000K (WarmWhite)
 6000 ~ 6500K (White)
 Daya Baterai : 5 Jam
 Berat : 95 gram



LED Bulbs Combo 5W

Tegangan : 70 ~ 285 VAC
 Daya : 5W
 Model : CMB05
 CCT : 2700 ~ 3000K (WarmWhite)
 6000 ~ 6500K (White)
 Daya Baterai : 10 Jam
 Berat : 225 gram



Dimensi

Model	Lebar	Tinggi
CMB05	550mm	115mm
CMB12	680mm	138mm



LED TUBE / LED TUBES EMERGENCY

LED Tubes T5

Tegangan : 70 ~ 285 VAC
 Daya : 4W, 7W, 17W
 Model : ST30, ST60, ST120
 Frekuensi : 50 ~ 60 Hz
 Power Factor : ≥ 0.90
 Power Efisiensi : $\geq 90\%$
 LED Efisiensi : $\geq 110 \text{ lm/W}$
 LED Lifetime : 50.000 jam
 CCT : 2700 ~ 3000K (WarmWhite)
 6000 ~ 6500K (White)



Dimensi

Model	Panjang	Lebar	Tinggi	Berat
ST30	300mm	27mm	30mm	65gram
ST60	600mm	27mm	30mm	105gram
ST120	1200mm	21mm	30mm	210gram

LED Tubes T8

Tegangan : 70 ~ 285 VAC
 Daya : 9W, 18W
 Model : SE60, SE120
 Frekuensi : 50 ~ 60 Hz
 Power Factor : ≥ 0.90
 Power Efisiensi : $\geq 90\%$
 LED Efisiensi : $\geq 110 \text{ lm/W}$
 LED Lifetime : 50.000 jam
 CCT : 2700 ~ 3000K (WarmWhite)
 6000 ~ 6500K (White)



Dimensi

Model	Panjang	Lebar	Tinggi	Berat
SE60	600mm	30mm	30mm	125gram
SE120	1200mm	30mm	30mm	235gram



LED Tubes Combo All in one

Tegangan : 70 ~ 285 VAC
 Model : CMT8-60A (60cm)
 CMT8120A (120cm)
 CCT : 2700 ~ 3000K (WarmWhite)
 6000 ~ 6500K (White)
 Daya Baterai : 5 Jam



LED Tubes T8 Combo

Tegangan : 70 ~ 285 VAC
 Model : CMT8-60 (60cm)
 CMT8-120 (120cm)
 CCT : 2700 ~ 3000K (WarmWhite)
 6000 ~ 6500K (White)
 Daya Baterai : 3 - 4 Jam



Dimensi

Model	Panjang	Lebar	Tinggi	Berat
CMT8-60	600mm	28mm	27mm	210mm
CMT8-120	1200mm	30mm	37mm	405mm
CMT8-60AP	255mm	30mm	31mm	255mm
CMT8-120AP	1200mm	27mm	30mm	350mm
SE120RP	1200mm	27mm	30mm	270mm

LED Tubes T8 Microwave Sensor

Tegangan : 70 ~ 285 VAC
 Daya : 9W, 18W
 Model : SE60R, SE120R
 Sistem : Power Off / Power Dimmable
 Timer : 15s, 30s, 60s, 10m (Custom)
 Sensitifitas Jarak: 6~ 8 Meter
 Color : 2700 ~ 3000K (WarmWhite)
 6000 ~ 6500K (White)
 Power Factor : ≥ 0.90
 Power Efisiensi : $\geq 90\%$
 LED Efisiensi : $\geq 110 \text{ lumens/watt}$



EMERGENCY SERIES



EMERGENCY CAT EYE

Tegangan	: 70 ~ 285 VAC
Daya	: 4W
Model	: Em25
Lumen	: 120 lm/Watt
Warna	: 2700 ~ 3000K (Warm White) 6000 ~ 6500K (White)
Berat	: 695Gram
Dimensi	: 268 x 640 x130 x117mm
Daya Baterai	: 1 Baterai 3 Jam / Maksimal Parallel Baterai 10 (Custom)



EMERGENCY CAT EYE

Tegangan	: 110 - 240V, 50/60Hz
Daya	: 0.56WW
Daya Baterai	: 1 Baterai 3 Jam
Pemasangan	: Hanging
Material	: Glass + Aluminium Shell
Berat	: 695Gram
Batterai	: 1.2 V 900 mAh NI-CD Battery
Dimensi	: 350 x 250 x 145mm
Berat	: 240 Gram



LED CORN LIGHT SERIES



LED Corn Light

- Tegangan : 70 ~ 285 VAC
- Daya : 4W, 6W, 10W, 16W, 36W (Dimmable Support)
- Model : PC04, PC06, NSC10, NSC16, PC36
- Color : 2700 ~ 3000K (WarmWhite)
6000 ~ 6500K (White)
- Frekuensi : 50 ~ 60 Hz
- Power Factor : ≥ 0.90
- Power Efisiensi : $\geq 90\%$
- LED Efisiensi : ≥ 120 lumens/watt
- LED Lifetime : 50.000 jam



Dimensi

Model	Panjang	Tinggi	Diameter	Berat
PC04	30mm	80mm	30mm	25gram
PC06	30mm	90mm	30mm	35gram
NSC10	45mm	140mm	45mm	65gram
NSC16	55mm	177mm	55mm	140gram
PC36	85mm	235mm	85mm	585gram

LUMINOUS INTENSITY DISTRIBUTION

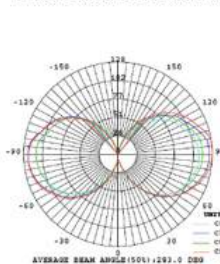

LUMINOUS INTENSITY DISTRIBUTION

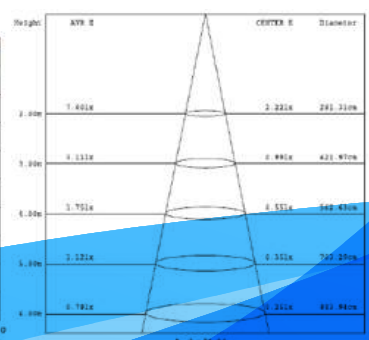
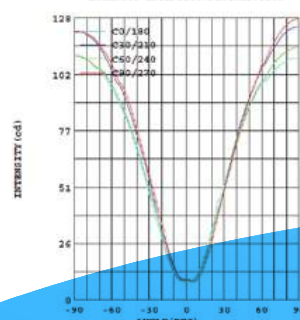

LED SPOT/ LED COB LIGHT SERIES

LED Spot Light

Tegangan : 70 ~ 285 VAC
 Daya : 3W, 5W, 7W, 9W, 12W
 (Dimmable Support)
 Model : SP03, SP05, SP07, SP09, SP12
 Color : 2700 ~ 3000K (WarmWhite)
 6000 ~ 6500K (White)
 Frekuensi : 50 ~ 60 Hz
 Power Factor : ≥ 0.90
 Power Efisiensi : $\geq 90\%$
 LED Lifetime : 50.000 jam

EMERGENCY
ENABLE



Model	Diameter	Tinggi	Cut Hole	Berat
SP03	Ø85mm	40mm	Ø52mm	130gram
SP05	Ø104mm	40mm	Ø75mm	210gram
SP07	Ø104mm	40mm	Ø74mm	205gram
SP12	Ø138mm	37mm	Ø98mm	280gram

LED Down Light COB

Tegangan : 70 ~ 285 VAC
 Daya : 5W, 9W, 15W, 20W, 30W
 (Dimmable Support)
 Model : SPCB03, SPCB04, SPCB05
 SPCB06
 Color : 2700 ~ 3000K (WarmWhite)
 6000 ~ 6500K (White)
 Frekuensi : 50 ~ 60 Hz
 Power Factor : ≥ 0.90
 Power Efisiensi : $\geq 90\%$
 LED Lifetime : 50.000 jam

EMERGENCY
ENABLE



LED Candle Light

Tegangan : 70 ~ 285 VAC
 Daya : 3W
 Model : SCB03P, SCB03K
 Color : 2700 ~ 3000K (WarmWhite)
 6000 ~ 6500K (White)
 Frekuensi : 50 ~ 60 Hz
 Power Factor : ≥ 0.4
 Power Efisiensi : $\geq 90\%$
 LED Efisiensi : ≥ 120 lumens/watt
 LED Lifetime : 50.000 jam



Model	Diameter	Tinggi	Cut Hole	Berat
SPCB03	Ø85mm	53mm	Ø52Inch	130gram
SPCB04	Ø103mm	53mm	Ø55Inch	210gram
SPCB05	Ø137mm	60mm	Ø95Inch	320gram
SPCB06	Ø190mm	50mm	Ø124Inch	405gram
Sp15	Ø130mm	90mm	Ø80Inch	410gram
Sp25	Ø165mm	120mm	Ø105Inch	600gram
Sp50	Ø190mm	140mm	Ø130Inch	600gram

Model	Panjang	Tinggi	Diameter	Berat
SCB03	45mm	115mm	24mm	25gram

LED SQUARE/LED ROUND PANEL SERIES



Round Panel Light

- Tegangan : 70 ~ 285 VAC
- Daya : 6W, 12W, 18W
(Dimmable Support)
- Model : SPP06, SPP12, SPP18
- Color : 2700 ~ 3000K (Warm White)
6000 ~ 6500K (White)
- Frekuensi : 50 ~ 60 Hz
- Power Factor : ≥ 0.90
- Power Efisiensi : $\geq 90\%$
- LED Efisiensi : ≥ 100 lumens/watt
- LED Lifetime : 50.000 jam



Dimensi

Model	Diameter	Tinggi	Cut Hole	Berat
SPP06	Ø120mm	20mm	Ø75mm	120gram
SPP12	Ø170mm	20mm	Ø127mm	170gram
SPP18	Ø225mm	20mm	Ø175mm	360gram
SPP45	Ø600mm	20mm	Ø543mm	2890gram

Square Panel Light

- Tegangan : 70 ~ 285 VAC
- Daya : 6W, 12W, 18W, 36W, 72W
(Dimmable Support)
- Model : SPR06, SPR12, SPR18,
SPR6060, SPR30120, SPR60120
- Color : 2700 ~ 3000K (Warm White)
6000 ~ 6500K (White)
- Frekuensi : 50 ~ 60 Hz
- Power Factor : ≥ 0.90
- Power Efisiensi : $\geq 90\%$
- LED Efisiensi : ≥ 100 lumens/watt
- LED Lifetime : 50.000 jam

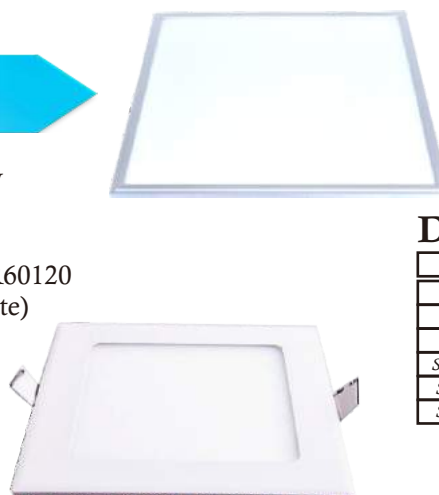

Dimensi

Model	Panjang	Lebar	Tinggi	Cut Hole	Berat
SPR06	120mm	20mm	120mm	78x78mm	145gram
SPR12	170mm	20mm	170mm	122x122mm	325gram
SPR18	225mm	20mm	225mm	173x173mm	535gram
SPR30120	1200mm	10mm	300mm	250x1150mm	2670gram
SPR6060	600mm	10mm	600mm	550x550mm	2670gram
SPR60120	1200mm	10mm	600mm	1550x550mm	5550gram

LED BEAN GLABBADER SERIES



Dimensi

Model	Panjang	Lebar	Tinggi	Cut Hole	Berat
Bg16	230mm	330mm	120mm	75x75mm	465gram
Bg30	273mm	110mm	160mm	90x90mm	675gram

Tegangan : 70 ~ 285 VAC
Daya : 16W (8W*2), 30W (15*2)
Model : BG16, BG30
Color : 2700 ~ 3000K (WarmWhite)
6000 ~ 6500K (White)

Beam Angel : 24
Frekuensi : 50 ~ 60 Hz
Power Factor : ≥ 0.90
Power Efisiensi: $\geq 90\%$

LED TRACK LED LIGHT SERIES



Dimensi

Model	Dimensi	Lebar	Tinggi	Cut Hole	Berat
R110	55mm	90mm	140mm	43mm	250gram
R115	100mm	135mm	210mm	90mm	610gram
R130	100mm	160mm	185mm	85mm	620gram

- Tegangan : 70 ~ 285 VAC
- Daya : 10W,15W,30w
- Model : RL10,RL15,RL30
- Color : 2700 ~ 3000K (WarmWhite)
6000 ~ 6500K (White)
- Frekuensi : 50 ~ 60 Hz
- Power Factor : ≥ 0.90
- Power Efisiensi: $\geq 90\%$
- LED Efisiensi : ≥ 120 lumens/watt
- Beam Angel : $\geq 360^\circ$
- LED Lifetime : 50.000 jam

EXPLOSIVE PROOF SERIES



Spesifikasi Exposable Proof T8

Tegangan	: 70 ~ 285 VAC
Daya	: 18W (1 Lampu T8), 36 (2 Lampu T8)
Model	: EP-TX 120 18W, EP-TX120 36W
Color	: 2700 ~ 3000K (WarmWhite) 6000 ~ 6500K (White)
Frekuensi	: 50~60 Hz
Power Factor	: ≥ 0.95
Power Efisiensi	: $\geq 90\%$
Led Efisiensi	: ≥ 110 Lumens/Watt
Led Lifetime	: 50.000 Jam
IP	: IP 67
Bahan	: Cast Caps Aluminium End, Aluminium Reflektor
Bahan Lensa	: Hardened Kaca Borosilicate Tabung

Spesifikasi Exposable Bulb

Tegangan	: 70 ~ 285 VAC
Daya	: 15W (1 Lampu Bulb), 36 (1 Lampu Corn)
Model	: EP-BX 15W, EP-BX 36W
Color	: 2700 ~ 3000K (WarmWhite) 6000 ~ 6500K (White)
Frekuensi	: 50~60 Hz
Power Factor	: ≥ 0.95
Power Efisiensi	: $\geq 90\%$
Led Efisiensi	: ≥ 110 Lumens/Watt
Led Lifetime	: 50.000 Jam
IP	: IP 67
Bahan	: Cast Caps Aluminium End, Aluminium Reflektor
Bahan Lensa	: Hardened Kaca Borosilicate Tabung

Dimensi

Model	Dimensi	Tinggi	Panjang	Berat
EP-TX 120 18W	95mm	-	1295mm	1.795Gram
EP-TX 120 36W	130mm	-	1285mm	3.135Gram
EP-BX 15W	120mm	262mm	-	1.050Gram
EP-BX 36W	215mm	350mm	-	2.250Gram

FLOOD LIGHT SERIES

Lampu Sorot

Tegangan	: 70 ~ 285 VAC
Daya	: 25W
Model	: F25
Frekuensi	: 50 ~ 60 Hz
Power Factor	: ≥ 0.90
Power Efisiensi	: $\geq 90\%$
LED Efisiensi	: ≥ 120 lumens/watt
Beam Angel	: $\geq 120^\circ$
LED Lifetime	: 50.000 jam
Material	: Aluminium Alloy
IP Rating	: IP65



LUMINOUS INTENSITY DISTRIBUTION

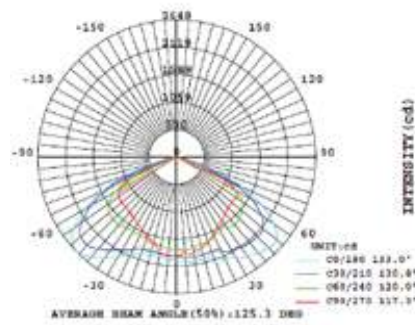

LUMINOUS INTENSITY DISTRIBUTION

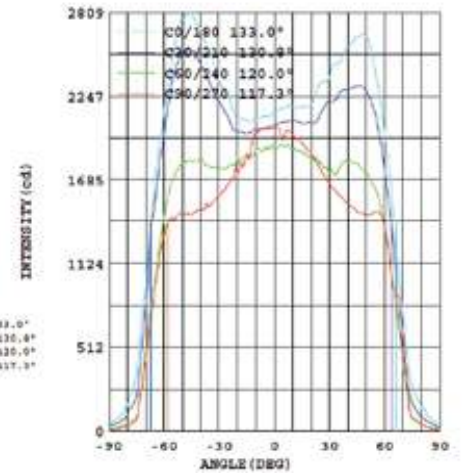

Flood Light

Tegangan	: 70 ~ 285 VAC 9 ~ 24 VDC (Solar Panel Enabled)
Daya	: 30W, 50W, 100W, 150W
Model	: SF30, SF50, SF100, SF150
Frekuensi	: 50 ~ 60 Hz
Power Factor	: ≥ 0.90
Power Efisiensi	: $\geq 90\%$
LED Efisiensi	: ≥ 120 lumens/watt
Beam Angel	: $\geq 120^\circ$
LED Lifetime	: 50.000 jam
Material	: Aluminium Alloy
IP Rating	: IP65



FLOOD LIGHT SERIES



Flood Light

- Tegangan : 70 ~ 285 VAC
- Daya : 500W, 1000W
- Frekuensi : 50 ~ 60 Hz
- Power Factor : ≥ 0.90
- Power Efisiensi : $\geq 90\%$
- LED Efisiensi : ≥ 120 lumens/watt
- Beam Angel : 60°
- Model : HP500, HP1000
- LED Lifetime : 50.000 jam
- Material : Alumunium Alloy, Fin Cooling Module, Tempered Glass

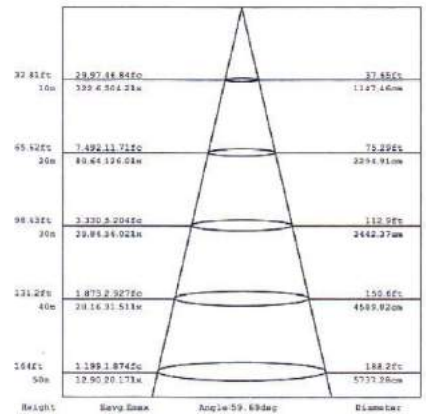
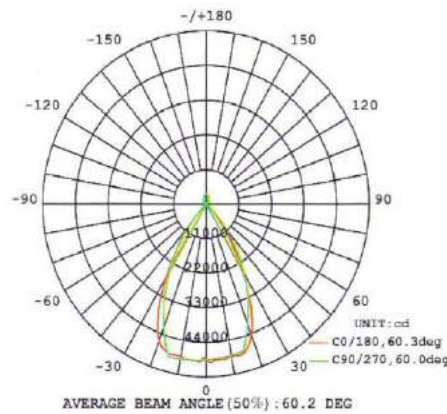

Lampu Sorot

- Tegangan : 70 ~ 285 VAC
- Daya : 100W, 200W, 300W, 400W, 500W
- Frekuensi : 50 ~ 60 Hz
- Power Factor : ≥ 0.90
- Power Efisiensi : $\geq 90\%$
- LED Efisiensi : ≥ 120 lumens/watt
- Beam Angel : 60°
- Model : F100, F200, F300, F400, F500
- LED Lifetime : 50.000 jam
- Material : Alumunium Alloy, Fin Cooling Module, Tempered Glass



HIGHBAY SERIES



High Bay Light UFO

Tegangan	: 70 ~ 285 VAC
Daya	: 50W, 100W, 200W
Model	: SR50, SR100, SR200
Frekuensi	: 50 ~ 60 Hz
Power Factor	: ≥ 0.90
Power Efisiensi	: $\geq 90\%$
LED Efisiensi	: ≥ 120 lumens/watt
Beam Angel	: $\geq 110^\circ$
LED Lifetime	: 50.000 jam
Material	: Aluminium Alloy
IP Rating	: IP65



High Bay Light Polycarbonate

Tegangan	: 70 ~ 285 VAC
Daya	: 100W, 150W,
Model	: SRP100, SR150
Frekuensi	: 50 ~ 60 Hz
Power Factor	: ≥ 0.90
Power Efisiensi	: $\geq 90\%$
LED Efisiensi	: ≥ 110 lumens/watt
Beam Angel	: $\geq 67.5 \sim 120^\circ$
LED Lifetime	: 50.000 jam
Material	: Polycarbonate
IP Rating	: IP65



High Bay Light

Tegangan	: 70 ~ 285 VAC
Daya	: 50W, 100W, 200W
Model	: SR50, SR100, SR200
Frekuensi	: 50 ~ 60 Hz
Power Factor	: ≥ 0.90
Power Efisiensi	: $\geq 90\%$
LED Efisiensi	: ≥ 120 lumens/watt
Beam Angel	: $\geq 110^\circ$
LED Lifetime	: 50.000 jam
Material	: Aluminium Alloy
IP Rating	: IP65



FLOOD/PJU MODULE SERIES



PJU MODULE

- Tegangan : 70 ~ 285 VAC
8 ~ 24 VDC
(Solar Panel Enabled)
- Daya : (Custom) / Module 60W ~ 300W (Max)
- Frekuensi : 50 ~ 60 Hz
- Power Factor : ≥ 0.90
- Power Efisiensi : $\geq 90\%$
- LED Efisiensi : ≥ 120 lm/watt
(Optional cree 160 lm/watt)
- Beam Angel : $\geq 120^\circ$
- LED Lifetime : 50.000 jam
- Material : Alumunium Alloy (Custom Casing)
- IP Rating : Ip65
- Model : MSF 60W, 120W ~ 300W (Flood Series)
MLJ 120W ~ 300W (PJU Series)

CREE 



LED STREET LIGHT SERIES



Street Light SSE

Tegangan	: 70 ~ 285 VAC 8 ~ 24 VDC (Solar Panel Enabled)
Daya	: 20W, 40W, 60W, 120W
Model	: SSE20, SSE40, SSE60
Frekuensi	: 50 ~ 60 Hz
Power Factor	: ≥ 0.90
Power Efisiensi	: $\geq 90\%$
LED Efisiensi	: ≥ 120 lumens/watt
Beam Angel	: $\geq 120^\circ$
LED Lifetime	: 50.000 jam
Material	: Aluminium Alloy
IP Rating	: IP65

Street Light SNE

Tegangan	: 70 ~ 285 VAC 8 ~ 24 VDC (Solar Panel Enabled)
Daya	: 50W, 100W, 150W
Model	: SNE50, SNE100, SNE150
Frekuensi	: 50 ~ 60 Hz
Power Factor	: ≥ 0.90
Power Efisiensi	: $\geq 90\%$
LED Efisiensi	: ≥ 120 lumens/watt
Beam Angel	: $\geq 120^\circ$
LED Lifetime	: 50.000 jam
Material	: Aluminium Alloy
IP Rating	: IP65



STREET LIGHT SERIES



Solar Panel
Enabled

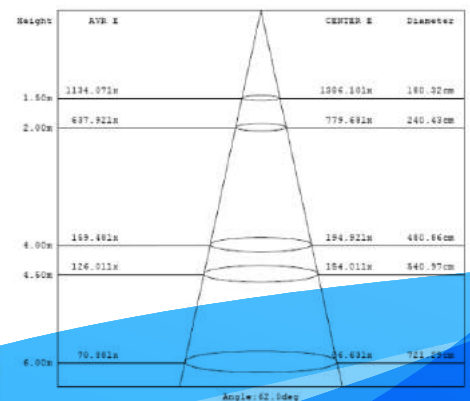
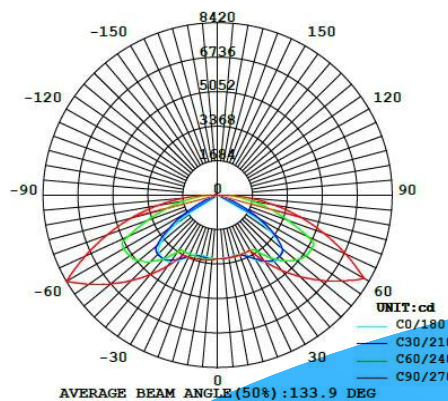

SENSOR CAHAYA OTOMATIS



SENSOR
CAHAYA OTOMATIS



*Sensor cahaya otomatis
bisa dipasangkan di
semua lampu LED AC kami*

SENSOR CAHAYA OTOMATIS

"Sensor cahaya otomatis mempunyai keunikan yaitu dapat menyala otomatis saat kondisi sekitar menjadi gelap. Tak hanya otomatis menyala saat gelap, Sensor unik ini bisa mati secara otomatis saat terkena cahaya disiang hari. jadi tidak perlu repot mematikan saklar lampu pada siang dan malam hari."

Aplikasi :

Dapat digunakan ditempat yang bisa menggunakan saklar dan tidak menggunakan saklar lampu

TEKNOLOGI SENSOR CAHAYA



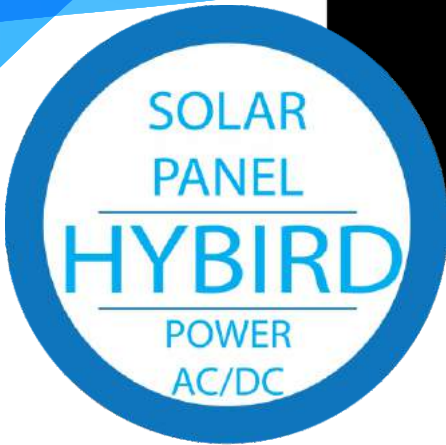

Spesifikasi

- Daya : 60W ~ 150W
- LED AC Efisiensi : ≥ 120 lumens/watt
- Battery : Li-Battery, Tesla Technology
- LED Lifetime : 50.000 jam
- On/Off Control : Build In Microprocessor automatic on/off during normal and emergency
- Sensor : build in motion sensor, on/off during day time and night time



"Hybird Power adalah dua fungsi ketika listrik mati otomatis menyala (DC) dan bisa menggunakan listrik langsung (AC)"



Spesifikasi

- Daya : 60W ~ 150W
- LED Efisiensi AC : ≥ 120 lumens/watt
- Battery : Li-Battery, Tesla Technology
- LED Lifetime : 50.000 jam
- On/Off Control : Build In Microprocessor automatic on/off during normal and emergency
- Sensor : build in motion sensor, on/off during day time and night time



Infrared Control



Timer



Waterprof



Lithium Battery

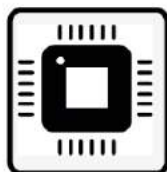

Microprocessor Green energy programmable

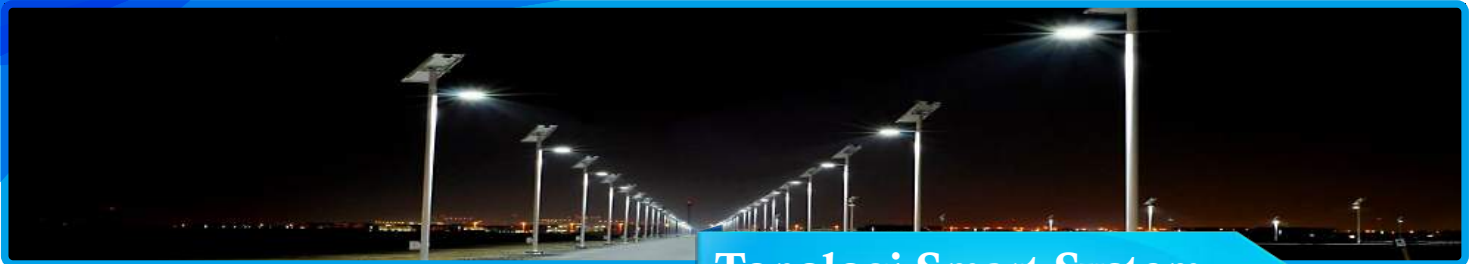

Topologi Smart System

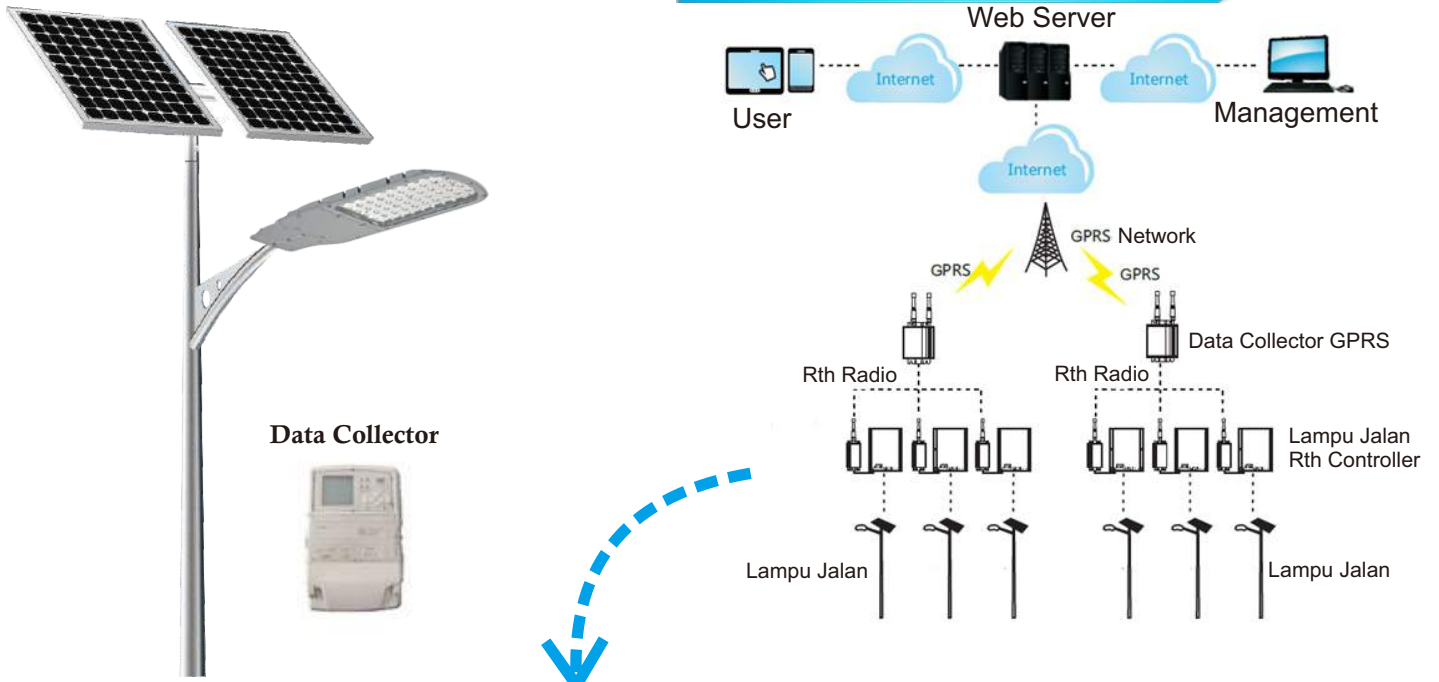

Komunikasi Nirkabel

- * Max 255 Rth Didalam satu data collector
- * Max 7 Segmen
- * Otomatis grouping. Otomatis bypass atau repeat otomatis
- * Network Otomatis Recovery
- * Broadcast dedicated control
- * Jarak Radio Signal 4 - 5 km
- * National wide
- * GPRS Network
- * 2 jalan koneksi
- * Free radio

Macam - Macam Topologi

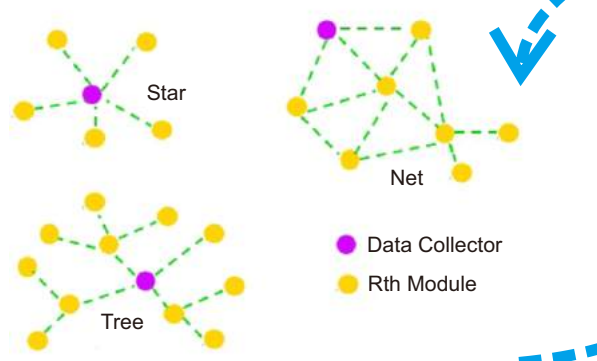

TOPOLOGY



OBSTRUCTION LIGHT



Obstruction Light

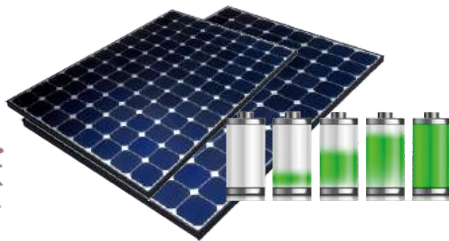

Tegangan : 90 ~ 285 VAC / 9 ~ 30V DC
Baterai/Solar Panel : Lithium Battery (Dc Version/Optional)
LED Lifetime : 100.000 jam
IP Rating : Ip67
Electronic Protection : Surge > 6.5KV Protection
Ambient temperature: -15 ~ 85 C
Aviation Standard : ICAO Low Intensity Type B (Min32Cd)
& FAA L-810
Model : Am01
Dimensi : 410 Gram
Berat : TxDxL (85x80x105)
Programming Flasing: Infrared

STREET LIGHT SOLAR CELL



Street Light Solar Cell

Daya	: 20W, 40W, 60W
Power Efisiensi	: \geq 90%
Daya Baterai	: \geq 12 jam
Beam Angel	: \geq 120°
Baterai	: Lithium Battery
IP Rating	: Ip65
AC/DC Hybird (Optinal)	

On/Off Control :

Menggunakan Mikroprosesor yang akan Otomatis On/Off pada siang hari dan malam hari.

Sensor :

Menggunakan sensor gerak, bila ada suatu objek bergerak maka LED akan menyala dengan tingkat kecahayaan 100%, dan bila tak ada Objek yang bergerak maka LED akan menyala dengan tingkat kecahayaan 30%.

Pengisian Ulang Baterai :

Dengan terik matahari penuh baterai akan terisi penuh dalam waktu 5-6 jam, bila pada saat hujan baterai akan tetap mengisi ulang sampai dengan 20%. Bila baterai penuh akan tetap bekerja selama 3 hari dengan kondisi turun hujan.



ACCESORIES LED & DISPLAY

Power Supply Outdoor



- Outdoor**
- * **Waterprof**
- * **Ip67**
- * **Lem Injection**

Tegangan : 230VAC - 5VDC
230VAC - 12VDC
Arus : 40A
3A, 5A, 10A, 20A, 35A
Model : PR5V20A, PR5V40A
PR12V3A, PR12V5A,
PR12V10A, PR12V20A
PR12V35A

Indoor / Outdoor

Power Supply Indoor

Tegangan
230VAC 20 - 30%
Kapasitas
200 Watt



Dimmable Switch



Strip Light

Power Supply 230VAC - 12VDC
Power 36W/Roll
1 Roll 5M
Ip67
Warna : Putih, Kuning
Full Color RGB (Controller)
LED Chip 2835



LIGHT+

THE SOLUTION OF LED

ADVERTISING SERIES





Running Text

Tegangan : 230VAC
Model : P3.75/P10 Satu Warna
P3.75/P10 Tiga Warna
P10 Semua warna
Aplikasi : Indoor / Outdoor
Dimensi : Custom Made
Optional : WIFI, GPRS, USB

Exposed LED

Power Supply : 230VAC - 5VDC
Single Color : LED Power 0.3W/LED
Diameter 8mm/LED
Full Colors : LED Power 0.8W/LED
Diameter 12mm/LED
1 Controller 2048 LED

IP65



LED Neon Box Indoor

Power Supply : 230VAC - 5VDC
Single Color : LED Power 0.3W/LED
Full Colors : LED Power 0.8W/LED
Diameter 12mm/LED
1 Controller 2048 LED

IP65

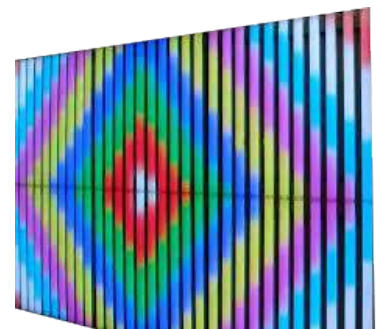

Point Lamp

Power Supply 230VAC - 12VDC
LED Power 3W/Point LED
Diameter 5cm/Point LED
1 Controller 2180/Point LED
IP65

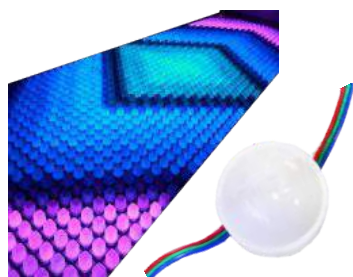

Flourescent Tubes

Power Supply 230VAC - 24VDC
Power Max. 9W / Tube
1 Controller 340 Tube
1 Tube 5 x 100 cm
IP65

VIDEOTRON SOLUTIONS

Videotron

Power Supply 230VAC - 5VDC

- P3 (Videotron Indoor)
- P5 (Videotron Indoor)
- P10 (Videotron Outdoor)

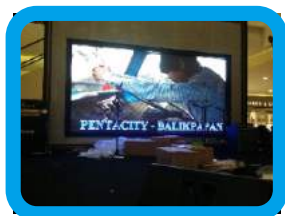

SYSTEM CONNECTION DIAGRAM

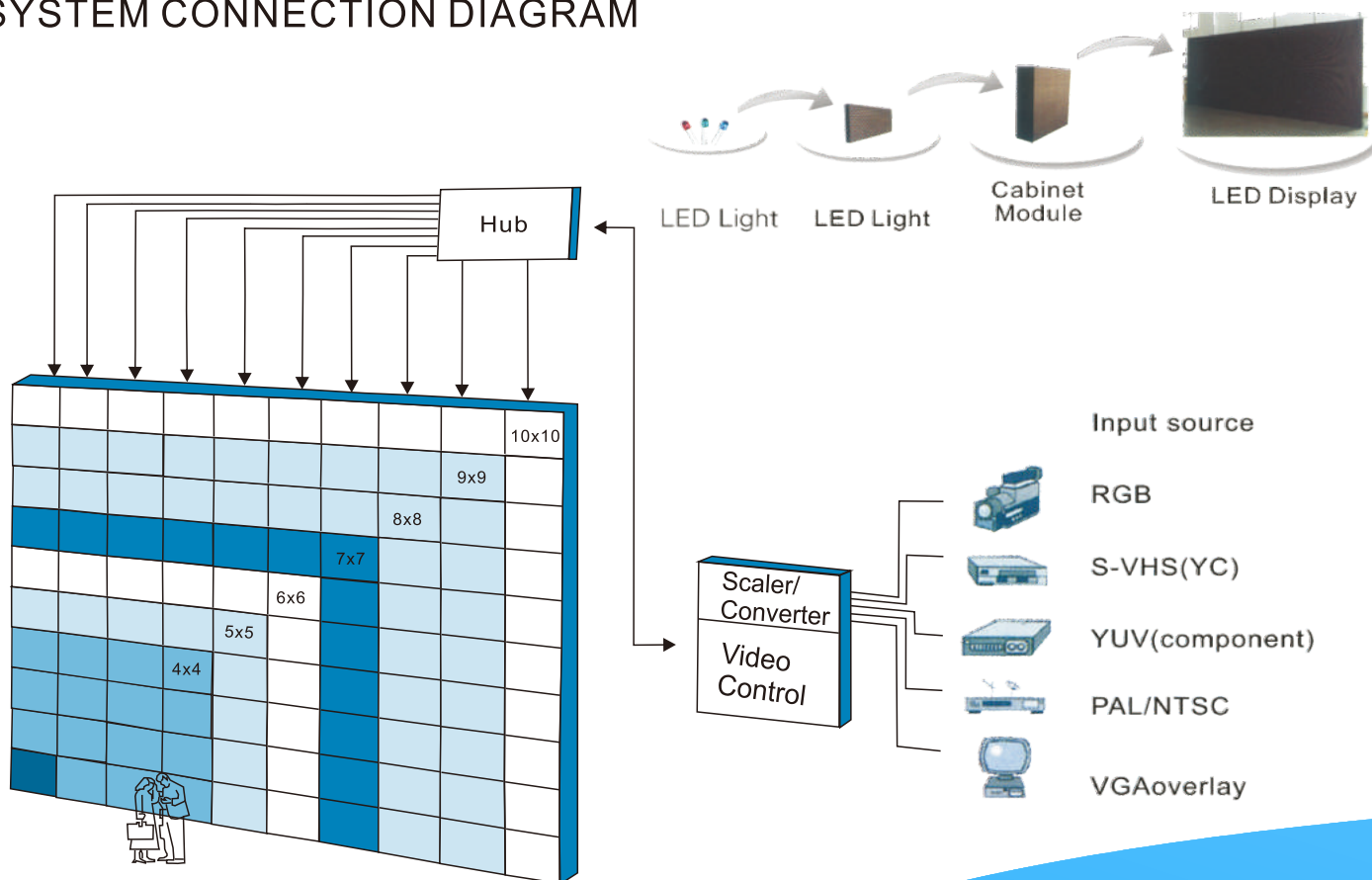

LIGHT+

THE SOLUTION OF LED

SHOWROOM LIGHTPLUS



LIGHT+

THE SOLUTION OF LED

CLIENT LIST



Belanja puas, harga pas



寶成國際集團
POU CHEN GROUP



GUNUNG SEWU



AGUNG PODOMORO LAND



PT. KAHATEX



PT. DEAN SHOES



PT KATSUSHIRO INDONESIA



LG Electronics



MEIKARTA
The future is here today

BUKAKA

PT. BUKAKA TEKNIK UTAMA



DEPARTEMEN PEKERJAAN UMUM JAWA BARAT



antam



PERTAMINA

PT. Pertamina (Persero)



PROPERTI

Beyond Space



ASTON CENGKARENG
CITY HOTEL & CONFERENCE CENTER



HOTEL SAHID JAYA LIPPO CIKARANG



J.CO



Pajok Busana

KOA SURFER HOTEL

LIGHT+

SOLAR PANEL SOLUTIONS



**SOLAR PANEL
ALL IN ONE
STREET LIGHT
HYBIRD POWER AC/DC**

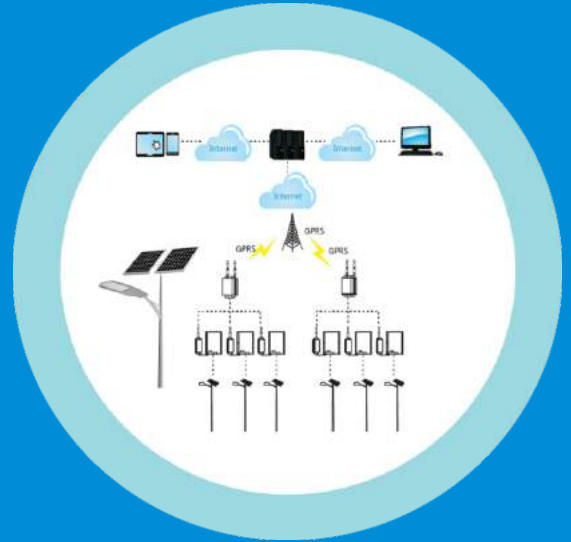

**SOLAR PANEL
SMART SYSTEM
STREET LIGHT**



**COMBO/EMERGENCY
TEKNOLOGI**



**SOLAR PANEL
HYBIRD POWER AC?DC
STREET LIGHT**